



PRODUCT GUIDE

CONTENTS



●
01

Structural Additions &
Options

●
11

Fireplace Options

●
15

Window Options

●
19

Plumbing Options

●
27

Electric Options

●
29

Exterior Trim Options

●
31

Exterior Door Options

●
35

Siding & Shingle
Options

●
37

Cabinet Styles

●
41

Specialty Cabinet &
Range Hood Options

●
45

Ceramic Tile Options

●
47

Countertop Options

●
51

Desk & Island Options

●
57

Interior Door and Trim
Options

●
59

Flooring Options

●
63

Interior Finish Options

●
65

Appliance Options



STRUCTURAL ADDITIONS & OPTIONS

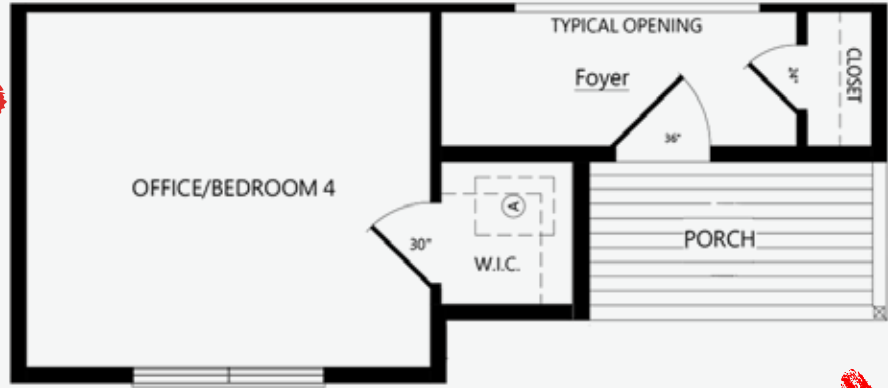

ADD A THIRD BOX CONFIGURATION

There are many customizations that can be added to the design of our homes. With your builder, adding more square footage, garages, and porches on site is always an option. All of these are popular ideas when building a home and we have designed modules, or boxes, to specifically tackle several of these at once. These modules can be added to many of our floor plans and with this one addition, space for an extra bedroom, office, or even workout room can be added. Along with extra interior space, front porch additions can be added for a dramatic change in curb appeal as well as adding an outdoor living space.



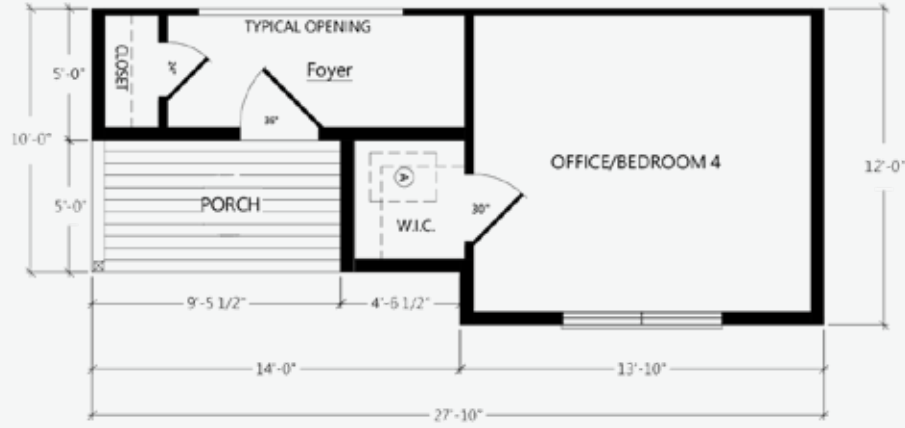

PORCH UNIT A: OP2008R

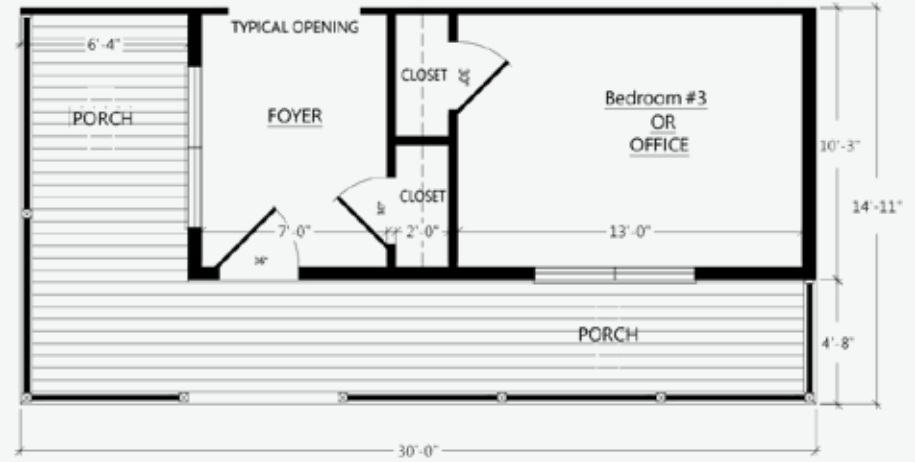

PORCH UNIT B: OP2009R

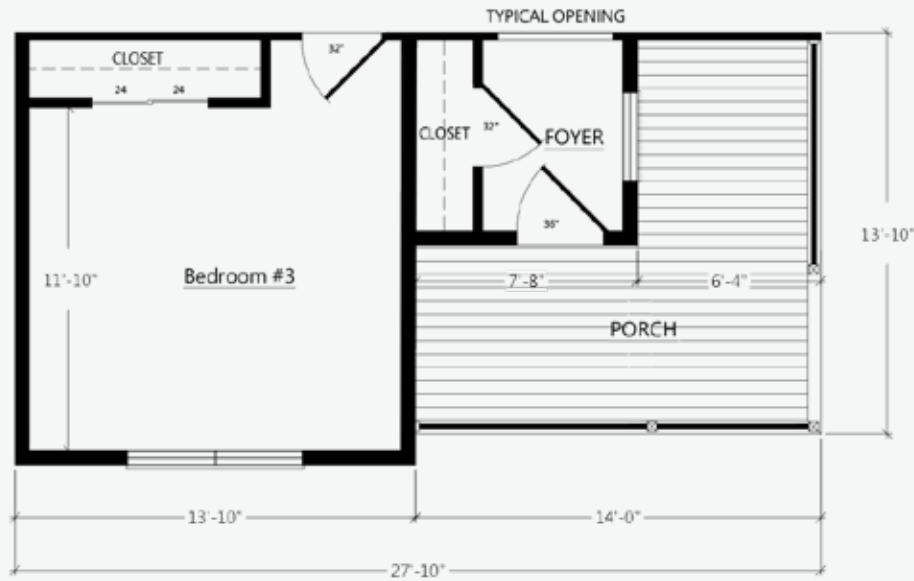

PORCH UNIT C: OP2010R

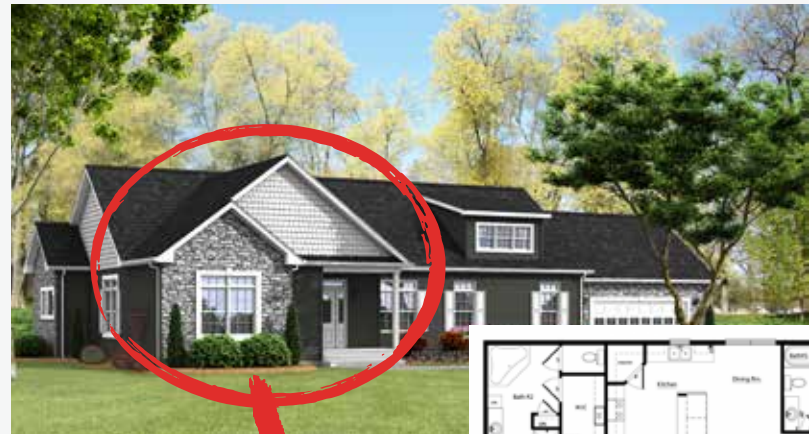

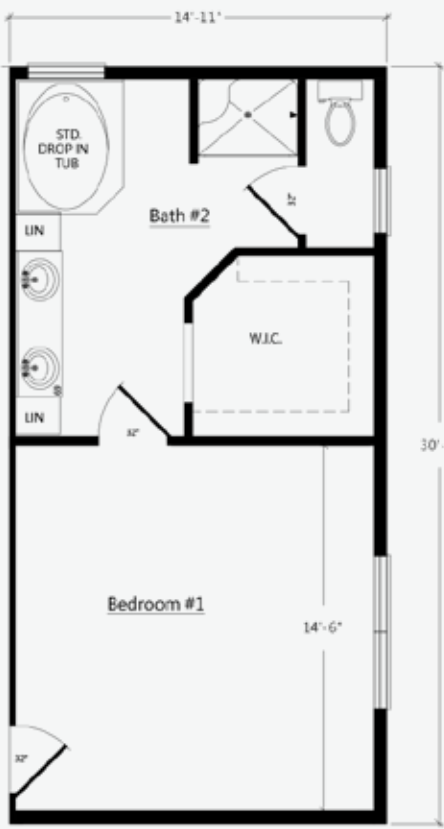

BED BATH UNIT A: OP2003R

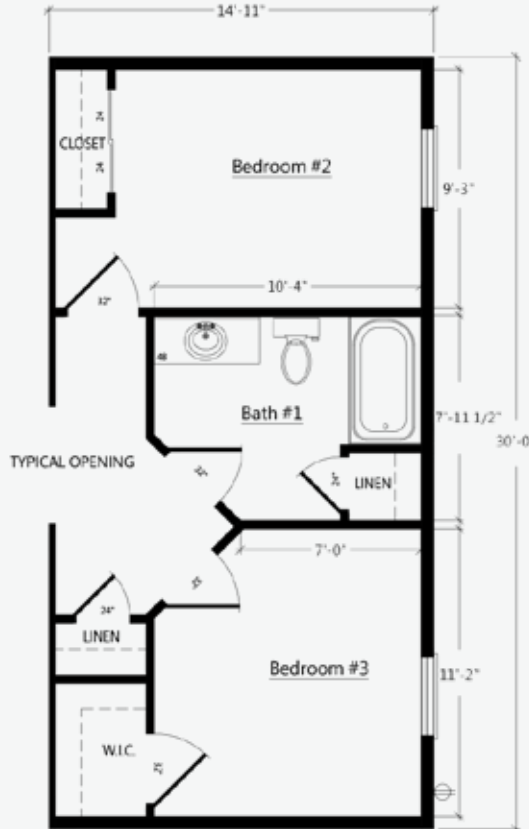

BED BATH UNIT B: OP2004R

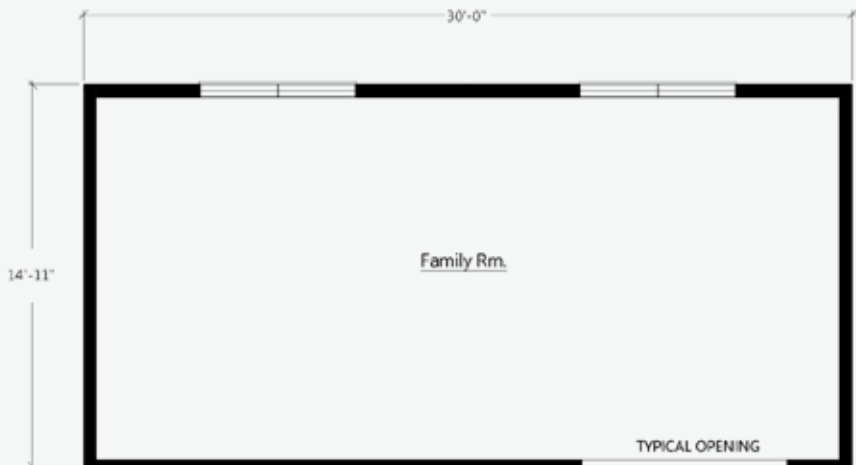

FAMILY ROOM

- 26ft: **OP2005R**
- 28ft: **OP2006R**
- 30ft: **OP2007R**



We have designed modules specific to getting more bedrooms and bathrooms in a home. These are especially appealing when added to one of our two story floor plans. Many people have used the bedroom addition modules for adding a main floor master suite or an in-law suite. Finally, we have a living room module that can be added to the side or back of almost any of our designs for additional living/family room. All of these additional boxes will enhance the dimension to a home creating a stunning exterior.



WHAT IS A ROOF RETURN?

Roof returns are an option on some of our gables and bump outs, a familiar term for these are eyebrows. The shingled line of the roof shown on the left is a good example. A roof return can be used to add decoration to a gable or as a break between a change in exterior façade.

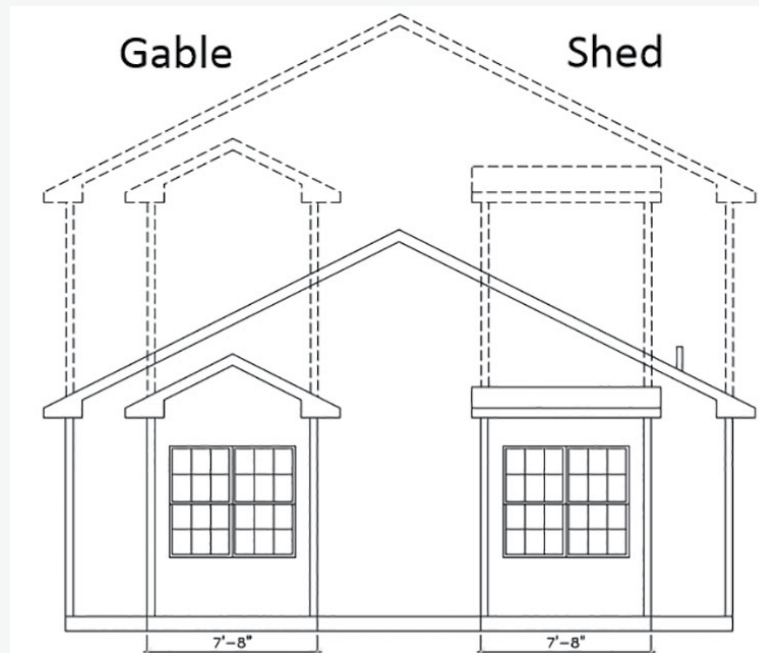

GABLE VS SHED

We offer two roof profiles on our dormers and bump outs. A gable style roof, where the roof lines come to a peak at the front, can be used to accent a traditional, transitional, or Victorian style home. A shed roof is a low sloped roof that moves in the same directions as the main roof line of a home. Most people use shed roofs to provide a craftsman, transitional, or even modern look.

DUTCH GABLE BUMP-OUT

Available on 6/12 or 9/12 Ranch or Two Story



No Roof Return Bump-out
Shown with 8' Sidewalls,
(2) 3050 Operable Windows,
and Lineals.
OP2013AR

Roof Return Bump-out
Shown with 8' Sidewalls,
(2) 3050 Operable Windows,
and Lineals.
OP2014AR



GABLE BUMP-OUT

Available on 6/12 or 9/12 Ranch or Two Story



Roof Return Bump-out
Shown with 8' Sidewalls,
(2) 3050 Operable Windows,
and Lineals.
Ranch: OP2016AR
Two Story: OP2028R

No Roof Return Bump-out
Shown with 8' Sidewalls,
(2) 3050 Operable Windows,
and Shutters.
Ranch: OP2015AR
Two Story: OP2024R



END WALL BUMP-OUT

Available on 6/12 or 9/12 Ranch or Two Story



10" Gable Bump Out
Shown with 3050 windows
Ranch: OP2011AR
Two Story: OP2019R

10" Shed Bump-out
Shown with 3050 windows
Ranch: OP2018AR
Two Story: OP2020R



TWO STORY GABLE BUMP-OUT

Available on 6/12 or 9/12 Two Story



Square Window Bump-out with (2) 3050
Windows and Shutters
OP2024R

RECESSED ENTRY



Recessed entry with stone or siding to
bottom of door.
Stone: OP3063AR
Siding: OP3062AR

GABLE DORMERS



6' 1" Gable Dormer with 3050 operable or fixed window
OP2033R
Available 9/12 or 12/12



11' Wide Gable Dormer with (2) 3050 fixed or operable Windows
OP2031R
Available 12/12

SHED DORMERS

Available 9/12 or 12/12



6' 1" Shed Dormer with 2030 operable or fixed Windows
OP2035R

11' Wide Shed Dormer with (4) 2030 fixed or operable Windows
OP2034R



8' COVERED PORCH

Available in 6/12, 9/12 Ranch Only

Full width porch or half width available. Porches can only be built on gable ends.
OP2002R



WHY YOU SHOULD ADD DORMERS



Adding one or more dormers to a roof's structure can turn a rather bland roofline into one with architectural interest and curb appeal. Not only do dormers improve the aesthetics of a home, but this upgrade will also make a home more appealing to buyers. When added to a home, dormers provide much-needed natural light and another view of the outdoors. Adding a large dormer will increase the usable space of a room. They are perfect spots for a reading nook, small office space or a kids' play area.



BENEFITS OF A HIGHER ROOF PITCH

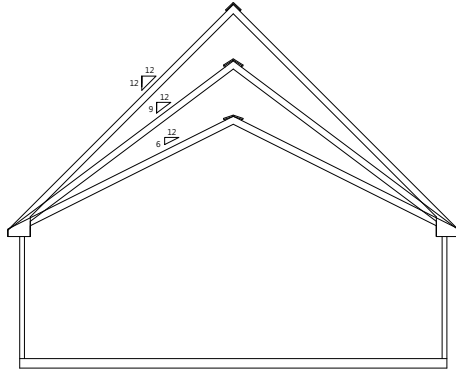

STARTING WITH 6/12

All of our 2 box standard ranch homes begin as a 6/12 roof pitch. Upgrade to a 9/12 or a 12/12 roof pitch to take advantage of exterior options such as a higher roof pitch and the ability to add dormers.

ATTIC SPACE & LIVING SPACE

A higher roof pitch encourages the development of larger attic spaces that are terrific for seasonal or long-term storage. The best part? This storage room often has very minimal installation expenses, as the space is already there. Depending on the pitch, there may even be enough space to convert this area into a functional living space. Many higher pitched roofs have windows installed for added natural light in the attic area.

EXTERIOR APPEAL

Many people adore homes with a higher roof pitch because they offer more visibility to a roof. A roof with a low pitch is usually not visible from ground level. A higher pitch can play a significant role in adding curb appeal to your home. These roofs make a home look more ornate and prominent from the outside. They also allow for the addition of decorative caps, inventive designs, and gables to your building. Higher roof pitches can turn a simple architectural style into a more visually complex one with just a few finishing touches.



Non Habitable 9/12 with 3/4 deck and 2x6 attic endwalls with R25 insulation under floor. (habitable option available)

Habitable 12/12 with 3/4 deck and 2x6 endwalls. R30 insulation under floor



Stairway Rail System
Handrail is not provided by RHI.
OP30033R



UPSTAIRS 12/12 FINISHED ON SITE

9/12 CATHEDRAL



9/12 Cathedral shown with (2) 3/0 x 3/0 fixed windows & (1) 3/0 x 6/0 fixed window.

Also available with (2) optional patio doors.

SILVERLINE

26 ft Wide: [OP3000R](#)
 28 ft Wide: [OP3001R](#)
 30 ft Wide: [OP3002R](#)

ANDERSEN

26 ft Wide: [OP3075R](#)
 28 ft Wide: [OP3076R](#)
 30 ft Wide: [OP3077R](#)

12/12 LOFTED CAPE



12/12 Lofted Cape shown with (2) 3/0 x 3/0 fixed windows & (1) 6/0 x 6/0 fixed window.

Also available with (2) optional patio doors.

SILVERLINE

26 ft Wide: [OP3025R](#)
 28 ft Wide: [OP3028R](#)
 30 ft Wide: [OP3031R](#)

ANDERSEN

26 ft Wide: [OP3078R](#)
 28 ft Wide: [OP3079R](#)
 30 ft Wide: [OP3080R](#)

LOFTED 9/12, FINISHED ON SITE

All cathedral and loft options have a similar interior to below



12/12 LOFTED CAPE



12/12 Lofted Cape shown with (2) fixed trapezoid windows & (1) fixed picture window. Also available with (2) optional patio doors.

SILVERLINE

26 ft Wide: [OP3027R](#)
 28 ft Wide: [OP3030R](#)

ANDERSEN

26 ft Wide: [OP3026R](#)
 28 ft Wide: [OP3029R](#)

12/12 Lofted Cape shown with (2) fixed trapezoid windows & (1) fixed twin picture window. Also available with (2) optional patio doors.

SILVERLINE

30 ft Wide: [OP3032R](#)

ANDERSEN

30 ft Wide: [OP3033R](#)



FIREPLACE OPTIONS

CUSTOMIZE YOUR FIREPLACE

STONE COLOR & STYLE



BUCKS CREEK



CHARLESTON



GALVESTON GRAY



HAMPTON GRAY



GRAPHITE



PRICE

FARMHOUSE MANTLE

Wrap around mantle, stain matches trim package

*Shiplap not available through RHI

[OP4024R](#)



60 INCH. BEAM MANTLES

Mantles constructed out of Maple

[OP4023R](#)



Farmstead

Weathered



FIREPLACE A



Fireplace A Stone front corner fireplace. Shown with Charleston Stone & Traditional Mantle
 Ranch Gas: [OP4001AR](#) Wood: [OP4000AR](#)
 Cape Gas: [OP4002R](#) Wood: [OP4003R](#)

FIREPLACE C



Fireplace C Stone front flat fireplace. Shown with Hampton Gray Stone & Traditional Mantle
 Ranch Gas: [OP4006AR](#) Wood: [OP4007AR](#) Cape Gas: [OP4004R](#) Wood: [OP4005R](#)

FIREPLACE F



Fireplace F Rave fireplace. Includes: Modern Fireplace with Black Trim
 Ranch Gas: [OP4013AR](#)
 Cape Gas: [OP4012R](#)

Note: *Media prep outlet is not included

FIREPLACE E



Fireplace E Stone front half wall fireplace. Shown with Graphite Stone & Traditional Mantle
Ranch Gas: **OP4010AR** Wood: **OP4011AR** Cape Gas: **OP4008R** Wood: **OP4009R**

FIREPLACE H



Fireplace H Stone front fireplace with Farmhouse Mantle. Shown with Bucks Creek stone.
Ranch Gas: **OP4019AR** Wood: **OP4020AR**
Cape Gas: **OP4018R** Wood: **OP4021R**

FIREPLACE G



Fireplace G Farmhouse fireplace. Shown with Bucks Creek Stone front Fireplace. Shelving with raised hearth and mantel, windows, (4) can lights and (2) eyeball lights. Total Length: 17' 4"
Ranch Gas: **OP4017R**
Wood: **OP4015R**
Cape Gas: **OP4016R**
Wood: **OP4014R**

Note: *Media prep outlet is not included

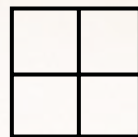

WINDOW OPTIONS

KNOW YOUR WINDOWS

SINGLE HUNG

Single-Hung windows allow ventilation through a single operable lower sash.

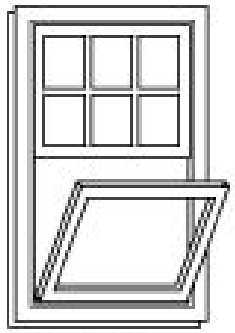

*View from inside

DOUBLE HUNG

Double-Hung windows have two operating sash that move up and down allowing for ventilation on the top, bottom or both.

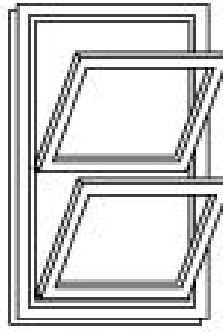

*View from inside

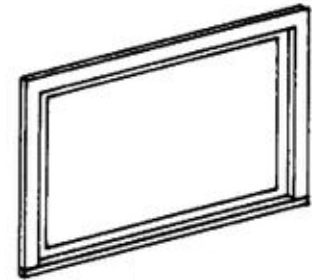

TRANSOM WINDOW

A window above a door that is usually installed to a horizontal crosspiece over the door.



*View from outside

AWNING WINDOW

Awning windows are hinged on the top and open outward from the bottom, allowing for ventilation and protection from the rain. Often placed higher on walls for privacy or in combination with large stationary windows for a better view.

CASEMENT WINDOW

Casement windows are hinged on the side and crank open outward to the left or right allowing for full top to bottom ventilation.

Standard above kitchen sinks, casement windows give you the flexibility to group them in stunning combinations.

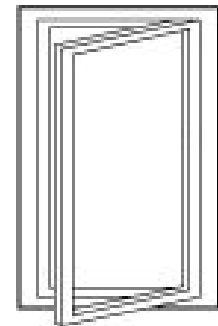

*View from outside



ADVANTAGES OF SILVERLINE

The Silverline Series offers a great vinyl window option that performs just as well as it looks.

- Low Maintenance Vinyl Interior and Exterior
- Standard with screen & colonial grids
- Casement Window in Kitchen, single hung
- 6' 0" Also available with 9' Sidewall Option
- Available in Double Hung
- Transoms also available
- Energy Star Rated
- Limited Lifetime Warranty

SOME POPULAR SILVERLINE OPTIONS

- Vinyl WDO 3050: [OP9038AR](#)
- Vinyl WDO 3060: [OP9041R](#)
- Vinyl WDO 2050 additional: [OP9034AR](#)
- Vinyl WDO 2030 tempered glass additional: [OP9032AR](#)
- Vinyl WDO 2630 tempered glass additional: [OP9037AR](#)
- Vinyl WDO 4050 w/two flanking windows: [OP9045R](#)
- Vinyl WDO Transom 12 inch: [OP9054AR](#)
- Vinyl WDO Awning 3015: [OP9046R](#)
- Vinyl WDO 2430 Casement additional: [OP9036AR](#)

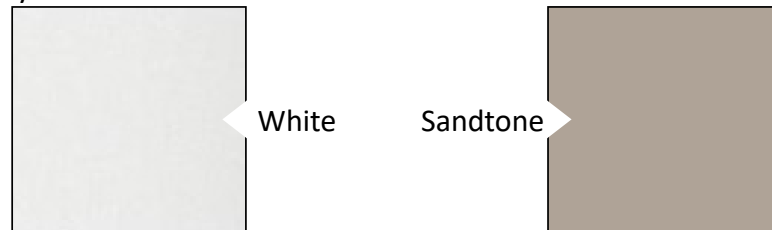



ADVANTAGES OF ANDERSEN

The 400 Series brings you the best overall blend of performance and style to satisfy just about any window or patio door need.

- Interior Wood Painted
- Wood Frame with Exterior Vinyl Clad
- Wood Sashes with Flexacron Finished Exterior
- Standard with screen and colonial grids
- Standard Double Hung with Casement in Kitchen
- Energy Star Rated
- Limited Warranty

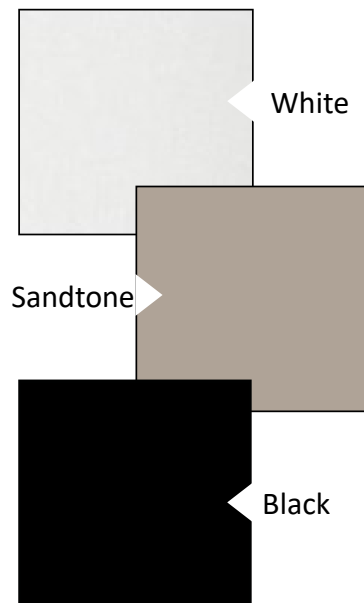

SOME POPULAR ANDERSEN OPTIONS

- Andersen 400 WDO TW210410: [OP9017R](#)
- Andersen 400 WDO TW210510: [OP9020R](#)
- Andersen 400 WDO TW20210: [OP9014R](#)
- Andersen 400 WDO TW24120: [OP9021R](#)
- Andersen 400 WDO Picture 310410 w/ 2 flanking: [OP9011R](#)
- Andersen 400 WDO Transom: [OP9013R](#)
- Andersen 400 WDO AR31 Awning 3'x17": [OP9009R](#)
- Andersen 400 WDO CW13: [OP9010R](#)



PLUMBING OPTIONS

BEST SELLING SHOWERS!

SHOWER OH!



Acrylic paneled shower with cultured marble print. 5'x5' shower pan with rainfall showerhead. Standard with transom window and two shower heads.

No shampoo niche

IPO 48" Shower and drop in tub [OP6045R](#)

(In Ceramic [OP6047R](#))

IPO 48" Shower [OP6046R](#)

(In Ceramic [OP6048R](#))

SERENITY SHOWERS



Shower N3

Serenity ceramic walk in shower, 1/2 wall, and glass, standard with block window, can light, rainfall showerhead, and Delta components

[OP6043R](#)

Shower N4

Serenity ceramic walk in shower with full bench, 1/2 wall, and glass, standard with block window, can light, rainfall showerhead, and Delta components

[OP6044R](#)

STANDARD SINKS



Standard stainless steel kitchen sink 8" depth



Standard China Lav Bowl



Black Kitchen Sink
 -Crafted from Nickel Quartz
 -Stain, impact, heat, and scratch resistant
 -Sound-deadening material
 -Hygiene protection
 -9" depth
OP6051AR

Kohler Vault Stainless Steel Single Bowl topmount, 10" depth
OP6055AR



OPTIONAL SINKS



Pedestal Sink
OP6057AR

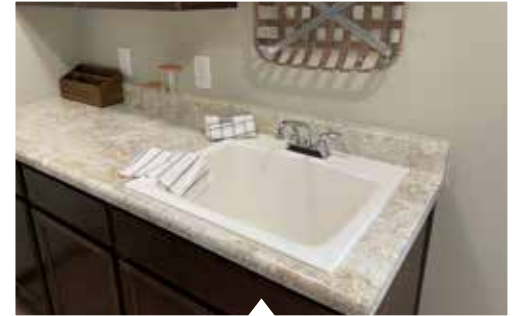

Washtub installed in cabinet
OP6059AR



Double Lavs
OP6053AR

CHOOSE YOUR FINISHES

STANDARD FAUCETS



Bathroom Faucet



Single Handle Kitchen Faucet with Spray Handle



Two Handle Laundry Faucet



Shower Trim



Tub/Shower Trim



see what Delta can do™

All Faucets are standard in Polished Chrome but can be upgraded to either Brushed Nickel or Oil Rubbed Bronze.

[OP6018AR](#)



STAND ALONE TUB FAUCETS



Stand Alone Tub Faucets are standard in Polished Chrome but can be upgraded to either Brushed Nickel or Oil Rubbed Bronze.

[OP6018AR](#)



FAUCETS UPGRADES



Single Handle Bar Faucet

[OP6050AR](#)

Color Options:



Single Handle Pull Down Kitchen Faucet

[OP6019AR](#)

Color Options:



SHOWER OPTIONS



Shower A
60" Tub/ Shower



Shower C
48" shower with sliding enclosure in place of 48" fiberglass with sliding enclosure.
OP6030AR
Available with ceramic on walls. No seat
OP6029R



Shower D
60" shower with enclosure in place of tub/shower.
OP6032AR
Available with ceramic on walls no seat.
OP6031R



Shower E
60x43 bench shower in place of standard tub/shower with enclosure.
OP6036AR



60in Chrome Barn Shower Door

- Contemporary barn door w/ a minimalist design
- Slim stainless header with 18 in. handle
- Chrome finish
- 78 3/4" high clear glass panel
- (Available with Shower OH! and 60in. Ceramic Only)

OP6033R



Tub/ Shower G
Fiberglass tub with ceramic tile on wall. Ivory, Calacatta, or Gray with accent. Includes shampoo niche.
OP6065R



Roll in shower
50x50 in place of standard w/(1) grab bar
OP6049AR
Fold down seat in roll in shower **OP6038AR**
Grab bar for tub/shower (1) **OP6039AR**
Hand held shower head(shower head only)
OP6040AR



TUB OPTIONS



Tub M
Ceramic backsplash for corner tub w/ (1) row of accent tile
OP6064R



Tub G
Drop in tub with laminate top

Tub L
Ceramic top on drop in tub, with 45" of backsplash, one row of accent tile
OP6063R



Tub H
72" tub in place of standard
OP6067AR



Tub I
Corner Fit Tub



Tub B
Garden/Tub shower in place of standard
OP6062AR



Free Standing Tub
Freestanding fiberglass tub in place of standard
OP6077AR

SHOWER TILE OPTIONS

OP6069R - Ceramic tile 12x24 with Silverado Grout

OP6047R - Shower OH! with Ceramic Tile IPO 48in. Shower and drop in Tub

OP6048R - Shower OH! with Ceramic Tile IPO 48in. Shower/Tub

SERENITY SHOWERS

N1 & N3



Shower N1
Serenity ceramic walk in shower standard with block window (not shown), can light, rainfall shower-head, and Delta components
OP6041R

Shower N3
Serenity ceramic walk in shower, 1/2 wall, and glass, standard with block window, can light, rainfall shower-head, and Delta components
OP6043R

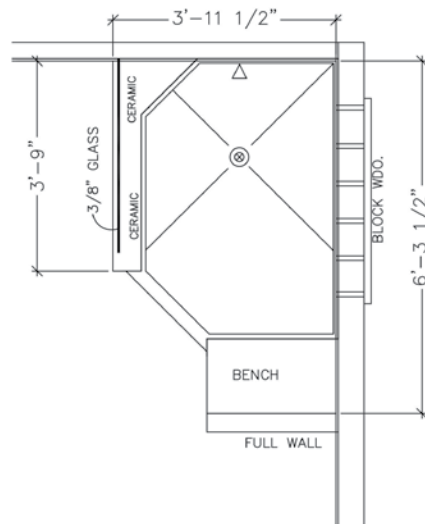

N2 & N4

Shower N2
Serenity ceramic walk in shower with full bench, standard with block window, can light, rainfall shower-head, and Delta components
OP6042R

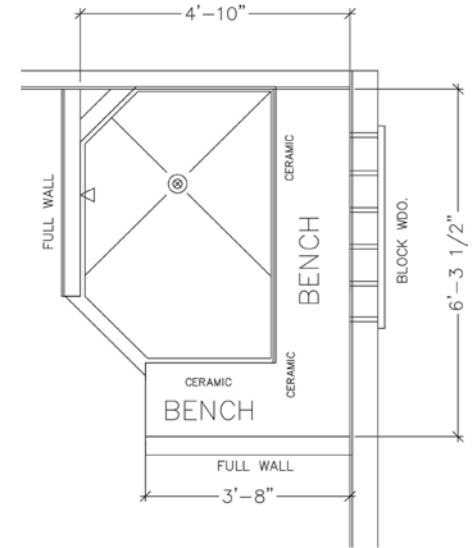

Shower N4
Serenity ceramic walk in shower with full bench, 1/2 wall, and glass, standard with block window, can light, rainfall shower-head, and Delta components
OP6044R

TRANQUILITY BATHS

T1 & T2

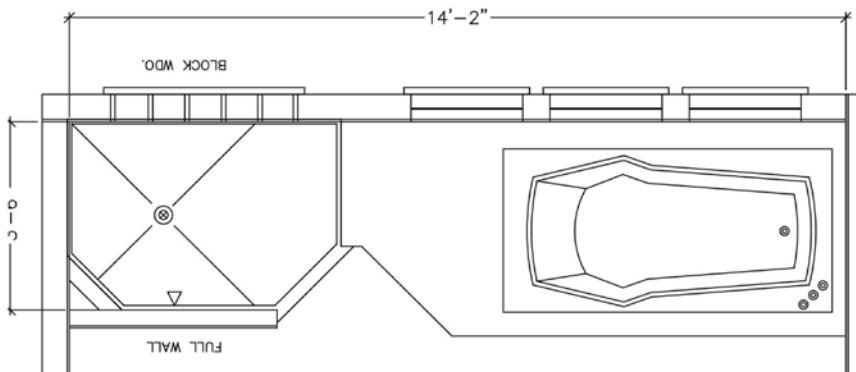

Shower T1

Ceramic walk in shower with 72" tub, may change plan, total length 14' 2". Includes windows & shutters shown, can light, rainfall shower head and Delta components

OP6021R

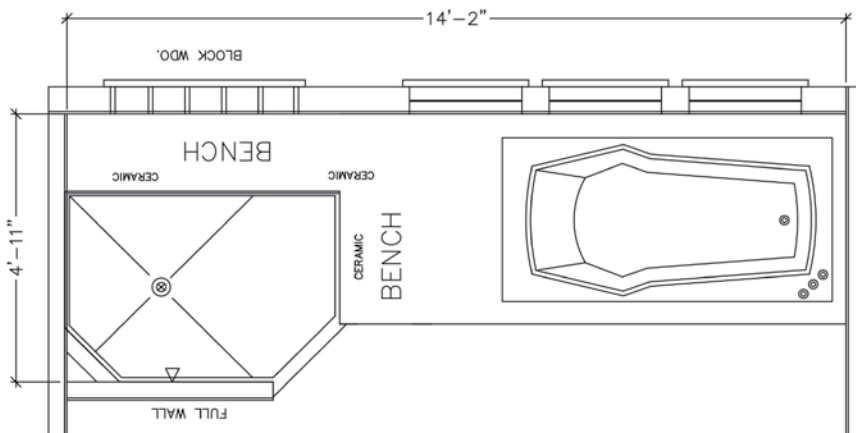

Shower T2

Ceramic walk in shower with 72" tub, may change plan, total length 14' 2". Includes full bench, windows & shutters shown, can light, rainfall shower head, and Delta components

OP6022R

T3 & T4

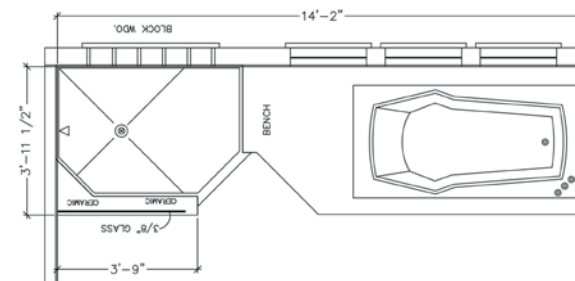

Shower T3

Ceramic walk in shower with 72" tub, may change plan, total length 14' 2". Includes 1/2 wall, and glass, windows & shutters shown, can light, rainfall shower head and Delta components

OP6023R

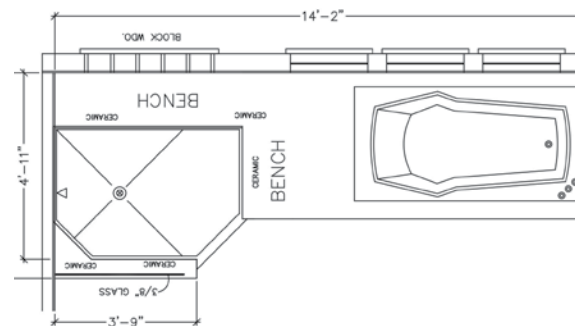

Shower T4

Ceramic walk in shower with 72" tub, may change plan, total length 14' 2". Includes full bench, 1/2 wall with glass, windows and shutters shown, can light, and rainfall shower head Delta components.

OP6024R



ELECTRIC OPTIONS

STANDARD BRUSHED NICKEL



Walk In Closet



Bedroom



Dining Room



Standard Morning Room/Open Foyer
Optional Foyer **OP7028AR**



Optional Pendant
OP7034AR

RUSTIC BRONZE OPTION



Walk In Closet



Dining Room



Optional Pendant
OP7034AR



Bedroom



Standard Morning Room/Open Foyer
Optional Foyer **OP7028AR**

MISC. OPTIONS



USB/Power in place of standard
OP7013AR
USB/Power outlet additional
OP7012AR

Standard Exterior Coach



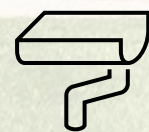

EXTERIOR TRIM OPTIONS

SHUTTERS

Raised Panel (Standard)/Board & Batten (Upgrade)



WINSTONE



DARK NAVY



WHITE



GRAY



BLACK



**PEBBLESTONE
CLAY**



PEPPERCORN



SPANISH MOSS



**BLACKWATCH
GREEN**



RED



5 1/2" trim (shown) replace shutters
white or clay
Ranch/Cape **OP11000AR**
Two Story **OP11002R**



EXT Trim-Sandtone/Clay trim package Ranch **OP11008AR** Two story **OP11005R** Cape Cod **OP11007R**
EXT Trim-Ranch Trim Package White: Window, Door, Drip Edge, Facia, and Soffit **OP11006AR**
Board and Batten Shutters replace standard Ranch/Cape **OP11003AR** Two Story **OP11004R**



EXTERIOR DOOR OPTIONS

DOOR HANDLE OPTIONS



Brushed Nickel
Exterior door knob and dead-bolt standard



Rustic Bronze
Exterior door knob and dead-bolt standard



Brushed Nickel
Exterior door decorative handle
OP8070AR



Rustic Bronze
Exterior door decorative handle
OP8070AR

PATIO DOORS



Therma-Tru 2 panel hinged with grids and screen
OP8063AR



Vinyl 2 panel sliding with screen
OP8064AR



RS130 6068 HPD Therma-Tru 2 panel hinged with blinds and screen
OP8065AR



Andersen Perma Shield 2 panel gliding with screen. No grids. Int/Ext match
OP8062AR



Andersen 2 panel sliding with screen. No grids. Ext. painted white.
OP8061AR

EXTERIOR DOOR OPTIONS

ALL DOORS AVAILABLE IN SMOOTH PAINT OR WOOD GRAIN STAIN



Door A
 Smooth Painted
 Upgrade Steel 6 Panel
 Fire Rated 20 min.
 Front or 90 min. Rear
OP8000AR



Door B: Decorative Oval
Painted Wood Grain
OP8002AR **OP8001AR**
 Sidelight:
OP8020AR OP8019AR
 Transom:
OP8037AR **OP8038AR**



Door C: Full Axis Glass
Painted Wood Grain
OP8004AR **OP8003AR**
 Sidelight:
OP8022AR OP8021AR
 Transom:
OP8039AR **OP8040AR**



Door D: 3/4 glass, 12 light
Painted Wood Grain
OP8006AR **OP8005AR**
 Sidelight:
OP8024AR OP8023AR
 Transom:
OP8041AR **OP8042AR**



Door E: 6 Light, Raised Panel
Painted Wood Grain
OP8008AR **OP8007AR**
 Sidelight:
OP8026AR OP8025AR
 Transom:
OP8043AR **OP8044AR**

PAINT COLORS





Door F: 9 Light, Exterior Grids
Painted Wood Grain
OP8010AR **OP8009AR**
 Sidelight:
OP8028AR OP8027AR
 Transom:
OP8045AR OP8046AR



Door G: 4 Light
Painted Wood Grain
OP8012AR **OP8011AR**
 Sidelight:
OP8030AR OP8029AR
 Transom:
OP8047AR OP8048AR



Door H: Half Glass
Painted Wood Grain
OP8014AR **OP8013AR**
 Sidelight:
OP8032AR OP8031AR
 Transom:
OP8049AR OP8050AR

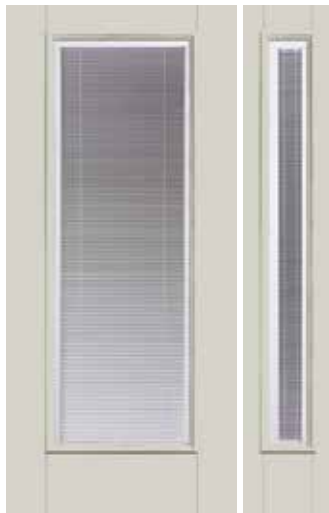

Door I: Full Glass with Blinds
Painted Wood Grain
OP8016AR **OP8015AR**
 Sidelight:
OP8034AR OP8033AR
 Transom:
OP8051AR OP8052AR



Door J: Sunburst, External Grids
Painted Wood Grain
OP8017AR **OP8091AR**
 Sidelight:
OP8036AR OP8035AR
 Transom:
OP8054AR OP8053AR

STAIN COLORS





SIDING & SHINGLES

TRUDEFINITION DURATION SHINGLES



Amber
OP12033AR



Desert Tan
OP12035AR



Brownwood
OP12031AR



Teak
OP12043AR



Driftwood
OP12036AR

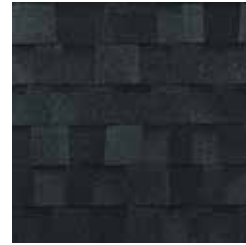

Onyx Black
OP12039AR



Estate Gray
OP12037AR



Terra Cotta
OP12044AR



Quarry Gray
OP12040AR



Sierra Gray
OP12042AR



Colonial Slate
OP12045AR



Harbor Blue
OP12038AR



Chateau Green
OP12032AR



Shasta White
OP12041AR



GROUP A STANDARD SIDING



GROUP B SIDING



GROUP C SIDING



GROUP D SIDING



STYLES



Siding groups A-D come in traditional lap.



Siding- Vinyl shingle in Gray, White, or Tan in place of:
Standard Siding - OP12027AR
Upgrade Siding - OP12028AR

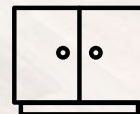

CABINET STYLES

STANDARD CABINET GROUP

Square recessed panel overhead and base cabinets-Partial Overlay

Ranch/Cape **OP13002AR**
Two-Story **OP13000R**



**SPRING VALLEY
MAPLE BOARDWALK**



**SPRING VALLEY
MAPLE PECAN**



**SPRING VALLEY
MAPLE DUSK**

CABINET CONSTRUCTION



We are America's Cabinetmaker.

Construction: 3/4" Solid wood face frames, reinforced and aligned with dowels and adhesive.

Drawers: Front is 3/4" thick. Also have WhisperGlide 75# capacity glides. Deluxe drawer option with 5/8" dovetailed construction and full extension undermount glides with soft-action technology available.

Roll Out Trays: Base cabinet roll out trays optional

Overhead Cabinet Shelves: 3/4" thick fully adjustable overhead shelves

Hinges: 6-way adjustable self closing concealed hinges with limited life time warranty

Warranty: 10-25 year limited warranty depending on cabinets

CABINET GROUP A

Square recessed panel overhead and base cabinets-Partial Overlay

Ranch/Cape **OP13005AR**
Two-Story **OP13006R**



**SPRING VALLEY
HICKORY**



**MARLIN MAPLE
BOARDWALK**



**MARLIN MAPLE
PECAN**



**MARLIN MAPLE
DUSK**



Note: Please see sample for true color

CABINET GROUP B

Ranch/Cape [OP13009AR](#)
 Two-Story [OP13010R](#)



**SPRING VALLEY
 MAPLE COTTON**



**SPRING VALLEY
 MAPLE GRAPHITE**



**SPRING VALLEY
 MAPLE NIGHTFALL**



**MARLIN MAPLE
 COTTON**



**MARLIN MAPLE
 GRAPHITE**



**MARLIN MAPLE
 NIGHTFALL**

DELUXE DRAWER PACKAGE



We are America's Cabinetmaker.

Available for classic line cabinets only in the Kitchen and Utility.

- Thicker core drawers- 5/8" thick drawer core provides a remarkably solid frame
- Dovetail drawer construction-durable and includes the SoftAction+ Tecnology on drawers only for a completely silent and effortless closing movement.
- Full extention drawers-allows the drawer to be completely opened.
- Plywood drawer bottom provides durable support to help resist sagging.

[OP13028AR](#) - Kitchen and Utility
[OP13029AR](#) - Kitchen, Utility and All Baths



Note: Please see sample for true color

CABINET GROUP C

Ranch/Cape **OP13019R**
Two-Story **OP13014R**

Square recessed panel overhead
and base cabinets- Full Overlay



**RALSTON MAPLE
BOARDWALK**



**RALSTON MAPLE
PECAN**



**RALSTON MAPLE
DUSK**



CABINET GROUP D

Ranch/Cape **OP13036R**
Two-Story **OP13018R**

Square recessed panel overhead
and base cabinets- Full Overlay



**RALSTON
MAPLE COTTON**



**RALSTON
MAPLE GRAPHITE**

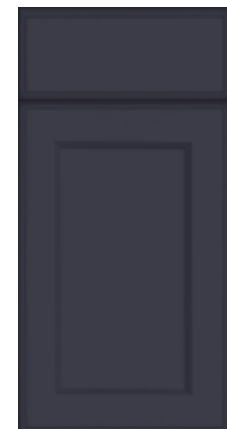

**RALSTON
MAPLE NIGHTFALL**

Note: Please see sample for true color



**SPECIALTY CAB/
RANGE HOOD**

STAINLESS STEEL RANGE HOOD

OP20004AR



STAINLESS STEEL WALL MOUNT

Stainless steel wall mount with ceramic back splash vented outside. Optional with extended glass and 36" opening with 30" range hood [OP14015R](#)



SPECIALTY CABINETS ADDITIONS

[OP14039AR](#) - Vanity storage over commode

[OP14040AR](#) - Medicine cabinet 24" replace mirror

[OP14041AR](#) - Medicine cabinet 36" replace mirror

[OP7011AR](#) - Under cabinet lighting

[OP14003AR](#) - 18" Additional bank of drawers

[OP13027AR](#) - Base cabinet roll out tray



Cabinet door knobs and drawer pulls, functional cabinets only [OP14008R](#)



Standard bathroom with trimmed mirror, pendant lights, and bank of drawers

OVERHEAD CABINET OPTIONS



Wall Wine Storage Cabinet
OP14043AR



24" overhead open bookshelf with organizer in place of overhead 2430
OP14018AR



Glass door on wall straight cabinet 15" or 18" square to match cabinets
OP14033AR



Wall Message Center on end of cabinet (36" or 42") **OP14042AR**

BASE CABINET OPTIONS



Double base waste basket top mount
OP14028AR

36" base pots and pans 2-Drawer in place of standard
OP14020AR



36" base pots and pans 3-Drawer in place of standard
OP14019AR



Tilt out sink tray
OP14036AR

9" base pull out pantry in place of standard cabinet
OP14023AR



36" Pantry with swing out racks in place of 18"
OP14000AR



Double pantry surround refrigerator
OP14029AR



Enclosed refrigerator 36 x 72/stacked washer/dryer. 30/78 opening with 24" deep overhead cabinet
OP14030AR

Universal wall oven unit in place of base and overhead
OP14038AR
Universal wall oven unit additional cabinet
OP14037AR

33"x90" w/30" Overhead Cabinets
33"x96" w/42" Overhead Cabinets
Appliance Opening Width 27"-31"
Opening Height 23 3/4"-47 1/4"



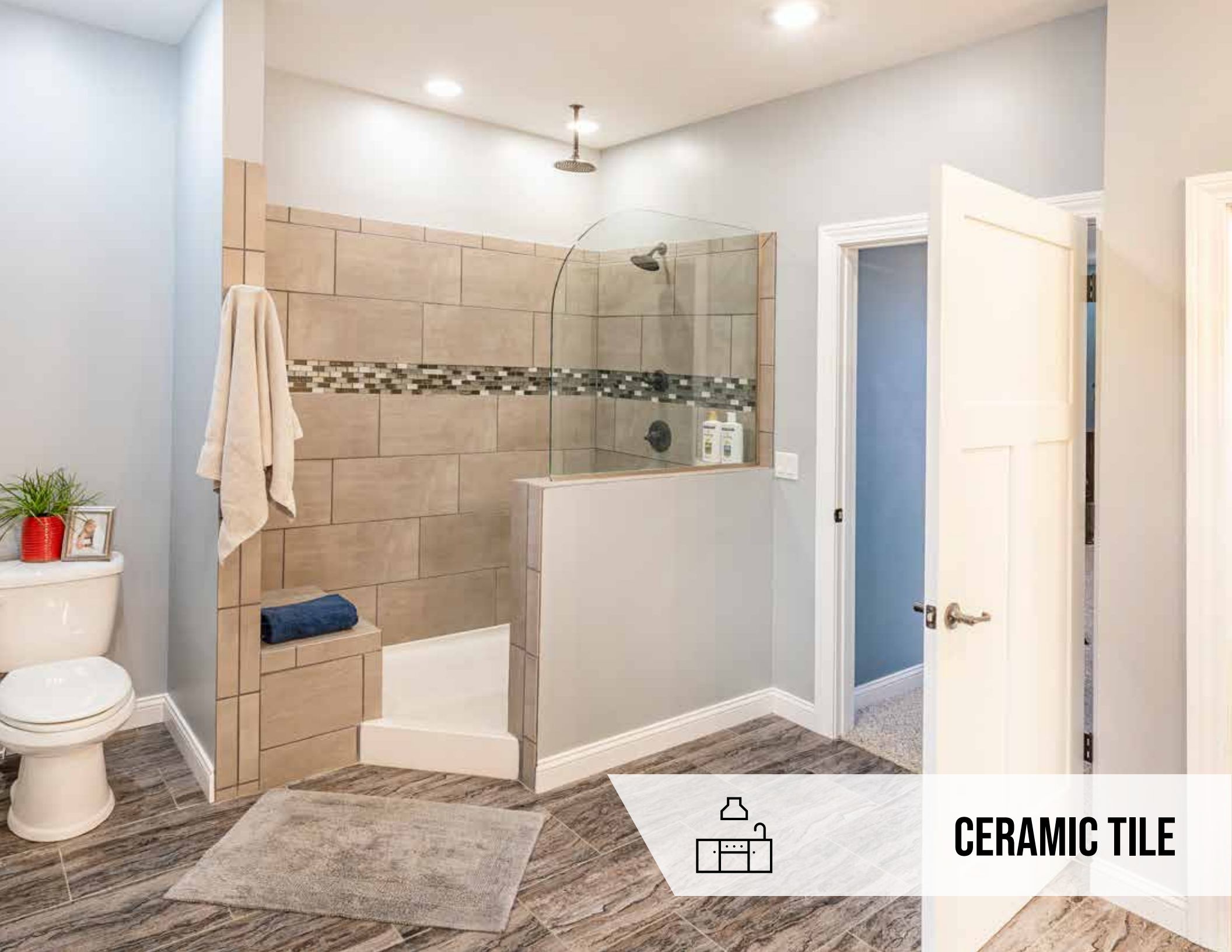

CERAMIC TILE

CERAMIC TILE COLORS



IVORY 12X24



CALACATTA 12X24



GRAY 12X24

TILE OPTIONS

BATHROOM

See Plumbing Options for showers available in ceramic. Only available in Silverado Grout.

KITCHEN

OP14015R - Rangehood - Stainless Steel wall mount with Ceramic Tile, Vented Outside. Choose grout color.

OP14017R - Rangehood - Stainless Steel wall mount with Subway Tile, Vented Outside. Choose grout color.

OP14016R - Rangehood - Stainless Steel wall mount with Decorative Tile, Vented Outside. Choose grout color.

OP14010R - Ceramic tile between backsplash and upper cabinet. Choose grout color.

OP14012R - Subway Tile - Installed in a brick pattern. Choose grout color.

OP14011R - Ceramic decorative accent tile, between backsplash and upper cabinet.

GROUT COLORS



SILVERADO



RAVEN

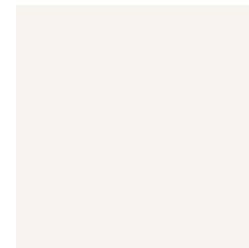

BRIGHT WHITE

ACCENT TILES

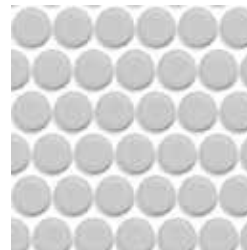

PENNY



MOSAIC



COUNTERTOPS

TOP QUARTZ COLORS



CALACATTA LAZA



ICED GRAY

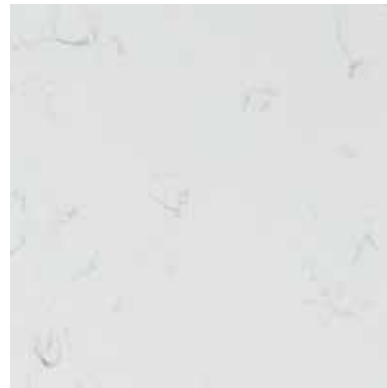

CARARRA MORRO

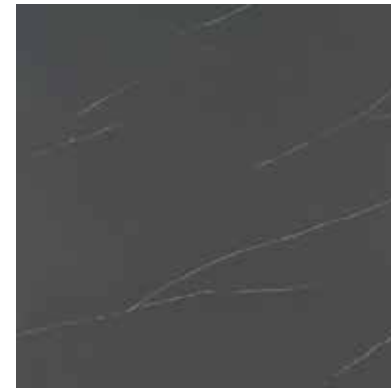

SOAPSTONE METROPOLIS

ADVANTAGES TO UPGRADING TO QUARTZ

We offer two countertop materials. Laminate countertops are a wood-based counter with a laminated print for a surface. A laminate countertop offers great affordability and has many styles to choose from. We choose to build our homes with a post form, rolled edge laminate top so that there are no seams from the front of your countertop all the way to the backsplash, which prevents damage from water penetrating seams or from physical damage to the top. If you choose to upgrade to a solid surface countertop, we move straight to the hardest top in the industry. Quartz is a manufactured product that has grown in popularity because of its durability, lack of need for major time in upkeep, and beautiful, eye-catching designs.



STANDARD COUNTERTOP COLORS



Pebble Piazza
OP15008AR



Oiled Soapstone
OP15007AR



White Juparana
OP15011AR



White Cascade
OP15010AR



Calacatta Oro
OP15003AR



Milano Quartz
OP15005AR



Natural Canvas
OP15006AR



Butterum Granite
OP15002AR



Jamocha Granite
OP15004AR

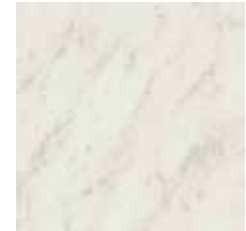

White Carrara
OP15009AR

UPGRADE COUNTERTOP COLORS



Marmo Bianco
OP15047AR



Drama Marble
OP15048AR



Italian White di Pesco
OP15044AR



Typhoon Ice
OP15049AR

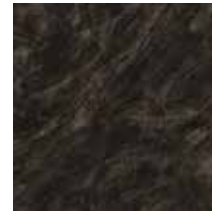

Sombra
OP15050AR



Crema Mascarello
OP15041AR



Dolce Vita
OP15042AR



Calacatta Marble
OP15036AR



Argento Romano
OP15038AR



Azul Aran
OP15039AR



Glacier Quartzite
OP15046AR



Antique Mascarello
OP15037AR



Fantasy Marble
OP15043AR



Cafe Azul
OP15040AR

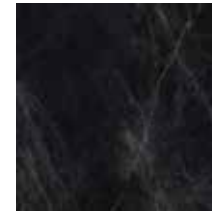

Jet Sequoia
OP15045AR

QUARTZ COUNTERTOP-GROUP A



Frosted White
OP15065R



Bayshore Sand
OP15070R



Iced Gray
OP15064R

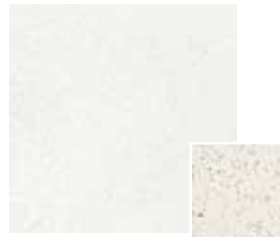

Sparkling White
OP15071R

QUARTZ COUNTERTOP-GROUP B



Manhattan Gray
OP15079R



Fossil Gray
OP15075R



Cararra Mist
OP15077R



Shell White
OP15078R



Cararra Morro
OP15074R

QUARTZ COUNTERTOP-GROUP C



Calacatta Botanica
OP15084R



Calacatta Laza
OP15087R



Soapstone Metropolis
OP15083R

COUNTERTOP THICKNESS

All quartz groups will be 3cm thick in the Kitchen and 2cm thick in the bathrooms. Vanitease options will be 2cm thick

VANITEASE LAV COUNTERTOP COLORS - BATHROOM ONLY

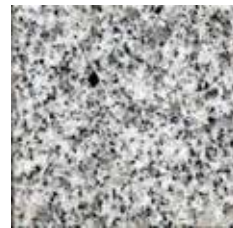

Meteorite G1-903
OP15028AR



Wheat G1-902
OP15030AR



Tigerskin White G1-904
OP15029AR

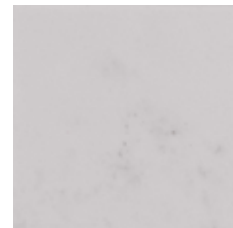

Tempest Carrara Q-1007
OP15032AR



Carrara Verta Q-3009
OP15031AR

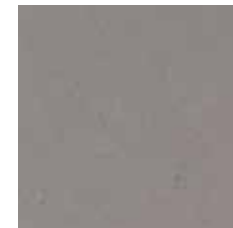

Terra Grey Q-3012
OP15033AR



DESKS & ISLANDS

Kitchen islands have become a real icon of the modern kitchen. Our kitchen islands come in a variety of shapes and sizes, and have the ability to be interchanged with a similar sized island to the one on the original plan.

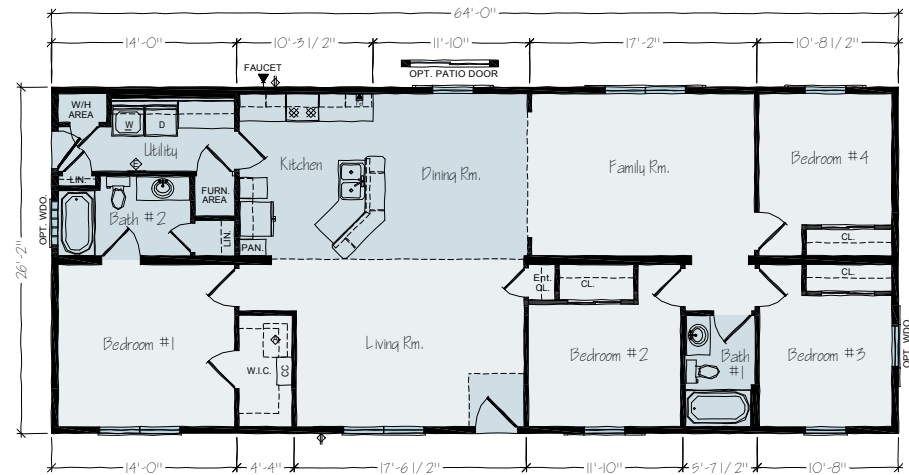

STANDARD DESK



Desk A Kitchen Unit
OP16000AR



Desk B 60" Hall Unit
OP16001AR



Desk C 57"x57" Corner Unit
OP16002AR



Desk D 81" Office Unit
OP16003AR



Desk E 135" Office Unit
OP16004AR

ISLANDS



Island A
4'3"x2'3" Island with 1" overhang all sides and receptacle on one end.
OP16005AR



Island B
4'3"x3' Island with 1" overhang on front and sides and 11" overhang on backside and receptacle on one end.
OP16006AR



Island I
6'4"x3'3" Island with overhang, kneehole on backside, glass doors square on one end and solid doors on opposite end, fluted legs at each corner and receptacle on backside of solid door cabinet.
OP16010AR



Island J
6'9"x3'6 1/2" Island with 1" overhang on front and one side, raised bar with 13" overhang on back with leg supports, 24"x42" shelf section on side, receptacle on one end.
OP16011AR



Island E
Angled Island with 1" overhang on front and sides, 11" overhang on backside with receptacle on one end **OP16007AR**



Island F
Angled Island with 1" overhang on front and sides, raised bar with 13" overhang on backside, receptacle on one end.
OP16008AR
Stone Backing **OP16009AR**





Island K
 Double angle island with 1" overhang on front and sides, raised bar with 13" overhang on backside, receptacle on both ends. (Shown with sink, will accommodate dishwasher)
OP16012AR
OP16013AR (stone backing)



Island L
 Double angle Island with 1" overhang on front and sides, raised bar with 13" overhang on back with supports, receptacle on one end.
OP16014AR

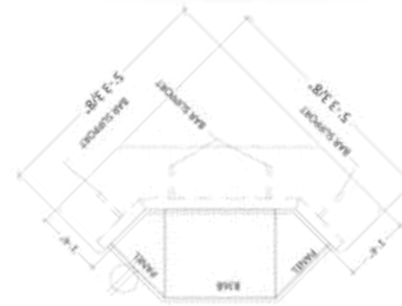

Island N
 4'6"x3'1" Island with 11" overhang on back, full leg supports each end and receptacle on one end.
OP16015AR



Island S
 6'5"x3'5" Island with overhang on back, (2) pots and pans drawers, and (2) straight legs. Receptacle on one end
OP16019AR





Island T
9'4"x4'2"
(2) large pots and pans
drawers, and (2) straight
legs
OP16020AR



Island Q
8'4"x3'5" island with
overhang on back,
bookshelf on side.
OP16017AR



Island P
6'4"x3'5" island with
overhang on back, (2) 4
bank of drawers. 39"
cabinet on side.
OP16016AR



Island R
5'4"x3'5" island with
overhang on back, 2
drawer pots and pans. 39"
cabinet on side.
OP16018AR





grateful
love
the ROWES
thankful
faith
blessed



INTERIOR DOORS & TRIM

6 PANEL DOOR



3 PANEL DOOR



2 PANEL DOOR



BARN DOOR HARDWARE



Brushed Nickel or Oil Rubbed Bronze barn door hardware on door to match

OP17001AR

Optional Pocket Doors (without privacy lockset)

OP17013AR

Optional Pocket Doors (with privacy lockset)

OP17014AR

TRIM PACKAGES

OP17017AR-STANDARD PACKAGE - Any door style in hollow core only, Trim Style 1, only in white.

OP17025R-PACKAGE A - Any door style in solid core, Trim Style 1, all trim colors available.

OP17026R-PACKAGE B - Any door style in solid core, Trim Style 2, all trim colors available.

TRIM COLOR

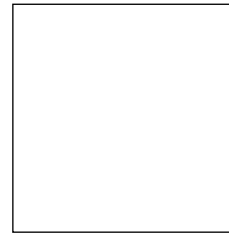

WHITE



COFFEE



BOARDWALK

TRIM STYLE

STYLE 1

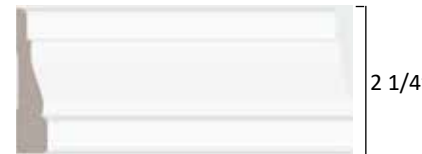

CASEMENT

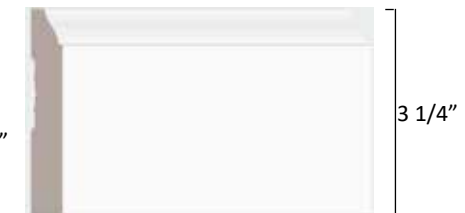

BASEBOARD

STYLE 2

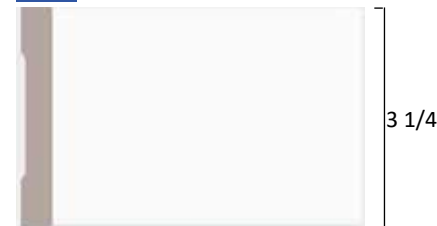

CASEMENT

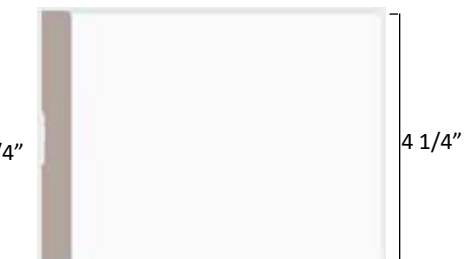

BASEBOARD

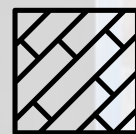

FLOORING

ADVANTAGE SERIES CARPET

Livewire II Carpet

- Nylon fibers and Polypropylene backing
- Treated with Shaw R2X Soil and Stain Resistance
Long-Term Protection Against Most Household Stains
Preserves and Protects Carpet's Appearance
Reduces Static Buildup
- Recyclable
- Resilient
- 13 oz. Carpet



Suede
OP18018A



Brownwood
OP18016A



Rockslide
OP18017A

STANDARD VINYL FLOORING



Barn Wood Greige
LX277 **OP18021AR**



Barn Wood Vintage White
LX275 **OP18022AR**

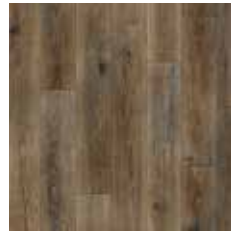

Aged European Oak Farmstead
LX310 **OP18019AR**



Meteor Hillsborough
Beige LX300 **OP18023AR**



Rockport Greyhound
LX285 **OP18024AR**



Saddle Ridge Weatherwood
LX295 **OP18026AR**



Vintage Plank Cafe Au Lait
LX290 **OP18020AR**

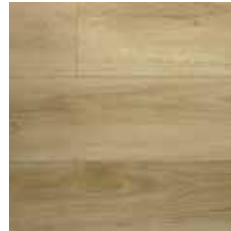

European Oak Aspen
LX327 **OP18027AR**



Boulder Eldorado Canyon
LX245 **OP18025AR**



Westport Harbor Light
LX330 **OP18028AR**

ROCHESTER SERIES GO SOFTLY CARPET 35 OZ.



Iced Coffee
OP18029AR



Kodiak Bear
OP18030AR



Natural Wood
OP18031AR



Pueblo
OP18032AR



River Bank
OP18033AR



Travertine
OP18034AR



Warm Oatmeal
OP18036AR



Twig
OP18035AR



Wheat
OP18037AR

ROCHESTER SERIES BLENDING UPWARDS CARPET 42 OZ.



Coastline
OP18038AR



Fog
OP18039AR



Mushroom
OP18040AR



Pleasant Valley
OP18041AR



Tree Swing
OP18043AR



Smoked Pearl
OP18042AR

ENCORE PLANK FLOORING - 7.08" X 48.03



Mitchell LUM-464
OP18047R

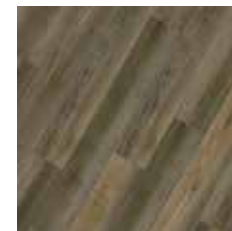

Mayville LUM-465
OP18046R

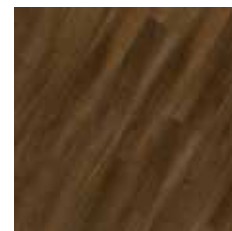

Crosby LUM-466
OP18044R

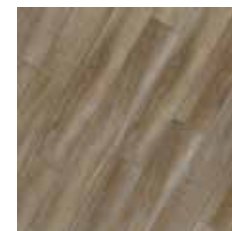

Mapleton LUM-467
OP18045R

ENCORE TILE FLOORING - 12" X 24"



Almont LUM-468
OP18048R



Ross LUM-469
OP18049R



Sharon LUM-470
OP18050R



Verona LUM-471
OP18051R



INTERIOR FINISH

BLINDS AND COLUMNS

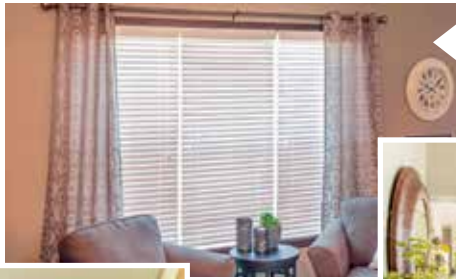

Blinds 2" faux white wood available on vinyl windows; excludes picture and transom
OP19017AR



Fluted wood column to match trim per pair
OP19007AR



Grand Archway 5' arch with fluted columns, wood capped 1/4 walls
OP19001AR

INTERIOR FINISHES



Closet Organizer Component Additional. White Only
OP19014AR
*standard in Master Walk-in Closet



Interior lever handle.
Brushed Nickel (Standard) **OP19013AR**
Rustic Bronze (Optional) **OP19016AR**

DRYWALL OPTIONS

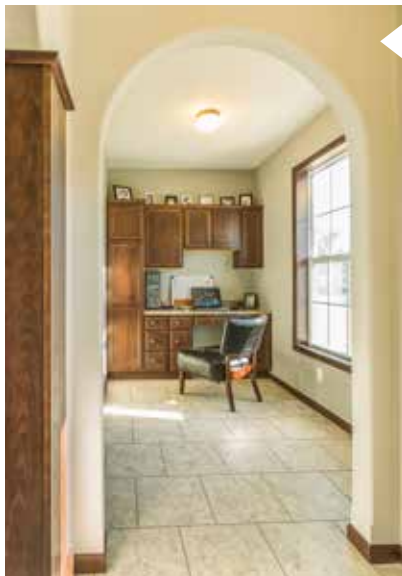

Drywall arch
4' **OP19008AR**
5' **OP19009AR**

Large opening drywall arch
OP19010AR



Coffered Ceiling with white crown moulding
OP19002AR



Tray Ceiling with 4 recessed can lights
OP19011AR

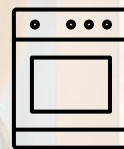

APPLIANCES

HOMEOWNER SAMSUNG PROGRAMS

Purchase through Rochester Homes for the best support service, and receive the following exclusive benefits

- 1 full year parts and labor plus 30 day cosmetic warranty on all products
- Dedicated Samsung Builder Service Support Team
- 3 year Warranty Program for Samsung packages that include refrigerator and laundry pair

SAMSUNG

PACKAGE A - STAINLESS OP20000AR



Samsung 21 Cu. Ft. Top Mount
[OP20005AR](#)

Samsung Dishwasher
[OP20001AR](#)



Samsung Electric Range
[OP20002AR](#)



OPTIONAL GAS RANGE IPO ELECTRIC RANGE



Samsung Gas Range
[OP20003AR](#)

Note: Fridge dimensions are 32 7/8" W x 67 3/4" H x 31 7/8" D and will not fill most fridge openings

PACKAGE B - STAINLESS OP20006AR



Samsung Side by Side Refrigerator
OP20007AR

- 27.5 Cu. Ft.
- LED Lighting
- 4 Tempered Glass Shelves
- In-Door Ice Maker
- External Water/Ice Dispenser



Samsung OTR Microwave
OP20008AR

- 1.6 Cu. Ft. Oven Capacity
- LED Display
- 300 CFM Ventilation System
- Turntable On/Off

Samsung Dishwasher
OP20001AR

- Quiet Operation – 55 dba
- Digital Leak Sensor
- Stainless Steel Interior Door/ polymer tub
- Nylon Racks
- Adjustable Upper Rack
- Top Controls



Samsung Electric Range
OP20002AR

- 5.9 Cu. Ft. Capacity Oven
- Hidden Bake Element
- Self Clean
- Wide View Window
- 5 Elements. 2 Dual. One Warming Center

OPTIONAL GAS RANGE IPO ELECTRIC RANGE



Samsung Stainless Gas Range
OP20003AR

- 5.8 Cu. Ft. Oven Capacity
- Hidden Bake Element
- 5 Burner Flexible Cooktop
- 17K BTU Power Burner
- Manual Clean Oven

PACKAGE C - STAINLESS OP20009AR



Samsung French Door Refrigerator
OP20013AR

- 27 Cu. Ft.
- Digital Inverter Compressor
- High Efficiency LED Lighting
- Twin Cooling – 2 Evaporators
- Ice Master makes 10 lbs. of ice per day
- Cool Select Pantry Temperature Controlled
- Filtered Water



Samsung OTR Microwave
OP20008AR

- 1.6 Cu. Ft. Oven Capacity
- LED Display
- 300 CFM Ventilation System
- Turntable On/Off

Samsung Dishwasher
OP20010AR

- Full Stainless Interior
- Digital Leak Sensor
- Quiet Wash 51 dba
- Front Controls with Pocket Handle
- Adjustable Nylon Racks
- Hidden Heat element



Samsung Electric Range
OP20011AR

- 5.9 Cu. Ft. Capacity Oven
- Hidden Bake Element
- 5 Elements. 2 Dual. One Warming Center
- Stainless Steel Cooktop and Die Cast Knobs
- Convection Oven

OPTIONAL GAS RANGE IPO ELECTRIC RANGE



Samsung Stainless Gas Range
OP20012AR

- 5.8 Cu. Ft. Oven Capacity
- Fan Convection Self Clean Oven
- Hidden Bake Element
- 5 Burner Flexible Cooktop
- 17K BTU Power Burner
- Comes with Griddle

PACKAGE D - STAINLESS OP20014AR



Samsung 4 Door French Door
OP20019AR

- 28 Cu. Ft.
- Flex Zone Drawer – 4 Temp., Kid Height
- Twin Cooling Plus – 2 Evaporators
- LED Lighting
- Digital Inverter Compressor
- Ice Master makes up to 10 lbs. per day



Samsung OTR Microwave
OP20016AR

- 1.9 Cu. Ft. Oven Capacity
- Ceramic Enamel Interior
- LED Display
- 400 CFM Ventilation System
- Simple Clean Filter

Samsung Dishwasher
OP20015AR

- Stainless Interior
- Digital Leak Sensor
- Quiet Wash 48 dba
- Hidden Heating Element
- Adjustable Nylon Racks
- Auto Release Door Dry



Samsung Electric Range
OP20017AR

- Flex Duo with Dual Door
- Dual Fan Convection & Air Fryer
- 6.3 Cu. Ft. Oven Capacity
- 5 Elements – 2 Dual for Flexibility
- Wi-Fi Connectivity Remote Control

OPTIONAL GAS RANGE IPO ELECTRIC RANGE



Samsung Stainless Gas Range
OP20018AR

- Flex Duo with Dual Door
- Dual Fan Convection Self Clean Oven
- 6 Cu. Ft. Oven Capacity
- 5 Elements – 2 Dual for Flexibility
- Wi-Fi Connectivity Remote
- Control/Monitor from your smart phone
- Air Fryer

PACKAGE D - BLACK STAINLESS OP20020AR



Samsung 4 Door French Door
OP20025AR

- 28 Cu. Ft.
- Flex Zone Drawer – 4 Temp., Kid Height
- Twin Cooling Plus – 2 Evaporators
- LED Lighting
- Digital Inverter Compressor
- Ice Master makes up to 10 lbs. per day



Samsung OTR Microwave
OP20022AR

- 1.9 Cu. Ft. Oven Capacity
- Ceramic Enamel Interior
- LED Display
- 400 CFM Ventilation System
- Simple Clean Filter

Samsung Dishwasher
OP20021AR

- Stainless Interior
- Digital Leak Sensor
- Quiet Wash 48 dba
- Hidden Heating Element
- Adjustable Nylon Racks
- Auto Release Door Dry



Samsung Electric Range
OP20023AR

- Flex Duo with Dual Door
- Dual Fan Convection & Air Fryer
- 6.3 Cu. Ft. Oven Capacity
- 5 Elements – 2 Dual for Flexibility
- Wi-Fi Connectivity Remote Control

OPTIONAL GAS RANGE IPO ELECTRIC RANGE



Samsung Stainless Gas Range
OP20024AR

- Flex Duo with Dual Door
- Dual Fan Convection Self Clean Oven
- 6 Cu. Ft. Oven Capacity
- 5 Elements – 2 Dual for Flexibility
- Wi-Fi Connectivity Remote
- Control/Monitor from your smart phone
- Air Fryer

PACKAGE E - STAINLESS OP20026AR



Samsung 4 Door Flex
OP20029AR

- 28.1Cu. Ft.
- Flex Zone - Bottom right can be freezer or refrigerator
- Largest fresh food capacity
- Makes up to 5 lbs of Ice per day
- Triple Cooling - 3 Evaporators
- LED Lighting



Samsung OTR Microwave
OP20016AR

- 1.8 Cu. Ft. Oven Capacity
- Ceramic Enamel Interior
- LED Display
- 400 CFM Ventilation System
- Simple Clean Filter

Samsung Dishwasher
OP20015AR

- Stainless Interior
- Digital Leak Sensor
- Quiet Wash 48 dba
- Hidden Heating Element
- Adjustable Nylon Racks
- Storm Wash
- Auto Release Door Dry



Samsung Double Wall Oven
OP20027AR

- Duel True Convection
- Two 5.1 Cu. Ft. Ovens
- WIFI Connectivity
- Hybrid Clean - Self Clean plus Steam
- Only Available in Electric



Samsung 30" Gas Cooktop
OP20002AR

- WIFI Connectivity
- 19K BTU dual Burner
- 5 Burners
- Available in Electric - **OP20036AR**

OPTIONAL MICRO/OVEN IPO WALL OVEN & OTR MICRO



Samsung Microwave Oven Combo
OP20087AR

- 5.1 Cu. Ft. Oven/ 1.9 Cu. Ft. Microwave
- Ceramic Enamel Interior
- Convection Microwave
- Steam Cook Oven for Professional Results
- Duel Fan Convection Oven
- WIFI Connectivity
- Self Clean plus Steam
- Only available in Electric

PACKAGE E - STAINLESS OP20030AR



Samsung 4 Door Flex
OP20033AR

- 28.1 Cu. Ft.
- Flex Zone - Bottom right can be freezer or refrigerator
- Largest fresh food capacity
- Makes up to 5 lbs of Ice per day
- Triple Cooling - 3 Evaporators
- LED Lighting



Samsung OTR Microwave
OP20022AR

- 1.9 Cu. Ft. Oven Capacity
- Ceramic Enamel Interior
- LED Display
- 400 CFM Ventilation System
- Simple Clean Filter

Samsung Dishwasher
OP20032AR

- Stainless Interior
- Digital Leak Sensor
- Quiet Wash 48 dba
- Hidden Heating Element
- Adjustable Nylon Racks
- Storm Wash
- Auto Release Door Dry



Samsung Double Wall Oven
OP20031AR

- Duel True Convection
- Two 5.1 Cu. Ft. Ovens
- WIFI Connectivity
- Hybrid Clean - Self Clean plus Steam
- Only Available in Electric



Samsung 30" Gas Cooktop
OP20035AR

- WIFI Connectivity
- 19K BTU dual Burner
- 5 Burners
- Available in Electric - **OP20036AR**

OPTIONAL MICRO/OVEN IPO WALL OVEN & OTR MICRO



Samsung Microwave Oven Combo
OP20085AR

- 5.1 Cu. Ft. Oven/ 1.9 Cu. Ft. Microwave
- Ceramic Enamel Interior
- Convection Microwave
- Steam Cook Oven for Professional Results
- Duel Fan Convection Oven
- WIFI Connectivity
- Self Clean plus Steam
- Only available in Electric

REFRIGERATOR OPTIONS



Samsung French Door

- 27 Cu. Ft.
- Digital Inverter Compressor
- High Efficiency LED Lighting
- Twin Cooling - 2 Evaporators
- Ice Master - 10lbs of Ice Per Day
- Cool Select Pantry
- Filtered Water
- Stainless - **OP20013AR**
- Black Stainless - **OP20049AR**



Samsung Side by Side

- 27.4 Cu. Ft.
- LED Lighting
- 4 Tempered Glass Shelves
- In-Door Ice Maker
- External Water/ Ice Dispenser
- Stainless - **OP20043AR**
- Black Stainless - **OP20042AR**



Samsung 4 Door Flex

- Flex Zone - Bottom right can be freezer or refrigerator
- Largest fresh food capacity
- Makes up to 8.6 lbs of Ice per day
- Triple Cooling - 3 Evaporators
- LED Lighting
- Stainless - **OP20040AR**
- Black Stainless - **OP20050AR**

Counter Depth Options Available

- Stainless - **OP20045AR**
- Black Stainless - **OP20044AR**



FAMILY HUB REFRIGERATOR

REPLACE WITH A FAMILY HUB REFRIGERATOR TO ANY PACKAGE - [OP20051AR](#)



Samsung Family HUB French Door

- 26.5 Cu. Ft.
- WIFI Connectivity Family HUB
- Voice Activation
- See Inside from anywhere
- Control from you smart phone
- Twin Cooling Plus - 2 evaporators
- Cool Select Pantry
- Stainless - [OP20056AR](#)
- Black Stainless - [OP20055AR](#)



Samsung Family HUB 4 Door Flex

- 27.9 Cu. Ft.
- WIFI Connectivity Family HUB
- Voice Activation
- See Inside from anywhere
- Control from you smart phone
- Flex Zone - Bottom right can be freezer or refrigerator
- Largest fresh food capacity
- Triple Cooling - 3 Evaporators
- Stainless - [OP20058AR](#)
- Black Stainless - [OP20057AR](#)

Counter Depth Options Available

- Stainless - [OP20052AR](#)
- Black Stainless - [OP20046AR](#)



Samsung Family HUB 4 Door French Door

- 27.4 Cu. Ft.
- Flex Zone Drawer - Kid Height
- WIFI Connectivity Family HUB
- Voice Activation
- See inside from anywhere
- Control from you smart phone
- Twin Cooling Plus - 2 evaporators
- Stainless - [OP20041AR](#)
- Black Stainless - [OP20059AR](#)

Counter Depth Options Available

- Stainless - [OP20054AR](#)
- Black Stainless - [OP20053AR](#)



Samsung Family HUB Side by Side

- 26.7.4 Cu. Ft.
- WIFI Connectivity Family HUB
- Voice Activation
- See inside from anywhere
- Control from you smart phone
- LED Lighting
- 25W Speaker
- Stainless - [OP20061AR](#)
- Black Stainless - [OP20060AR](#)



Samsung Under Cabinet Hood

- 390/600 CFM
- Baffle Filters
- LED Lighting
- Stainless - **OP20039AR**
- Black Stainless - **OP20039AR**

Samsung 30" Electric Cooktop

- 5 Burners - Two Dual
- Rapid Boil Element 3,300 KW
- WIFI Connectivity
- Stainless - **OP20036AR**
- Black Stainless - **OP20035AR**



Package A Samsung Top Load Washer/Dryer Electric White
OP20062AR/ OP20063AR

- 4.0 Cu Ft. Washer
- 7.2 Cu. Ft. Dryer
- Self Clean Washer
- VRT Vibration Reduction Technology
- Diamond Drum
- Sensor Dry Dryer



Package B Samsung Top Load Washer/Dryer Electric White
OP20064AR/ OP20065AR

- 5.0 Cu Ft. Washer
- 7.4 Cu. Ft. Dryer
- Self Clean Washer
- VRT Vibration Reduction Technology
- Sensor Dry Dryer



Package C Samsung Front Load Washer/Dryer Electric White
OP20066AR/ OP20067AR

- 4.2 Cu Ft. Washer
- 7.5 Cu. Ft. Dryer
- Self Clean Washer
- VRT Vibration Reduction Technology
- Smart Care
- Sensor Dry Dryer

LAUNDRY OPTIONS



- OP20083AR**- White Pedestal Drawer
- OP20079AR**- Stack Kit-Skk-8A
- OP20082AR**- Black Stainless Pedestal Drawer
- OP20078AR**- Smart Adapter



Package D Samsung Front Load Washer/Dryer Electric White

OP20068AR/ OP20069AR

- 4.5 Cu Ft. Washer
- 7.5 Cu. Ft. Dryer
- Self Clean Washer
- VRT Vibration Reduction Technology
- Stackable
- Sensor Dry Dryer

Package F Samsung Front Load Washer/Dryer Electric White

OP20074AR/ OP20075AR **OP20076AR/ OP20077AR**

- 4.5 Cu Ft. Washer
- 7.5 Cu. Ft. Dryer
- WIFI Connected and Smart Care
- Super Speed 36 min wash
- Steam Wash & Dry
- Sensor Dry Dryer
- VRT PLUS SENSOR Vibration Reduction System





1345 N. LUCAS ST. | ROCHESTER, INDIANA 46975

TOLL-FREE: 800.860.4554

LOCAL: 574.223.4321

FAX: 574.223.1655